



# HUMAC<sup>®</sup> NORM<sup>®</sup>

TESTING & REHABILITATION SYSTEM

*Measure & Improve  
Performance*



## Unparalleled Software and Mechanical Design

CSMi is proud to introduce the new HUMAC NORM Testing & Rehabilitation System. With the acquisition of CYBEX Medical, CSMi is now able to offer in one machine the industry-leading HUMAC Software coupled with the proven mechanical design of the CYBEX NORM.

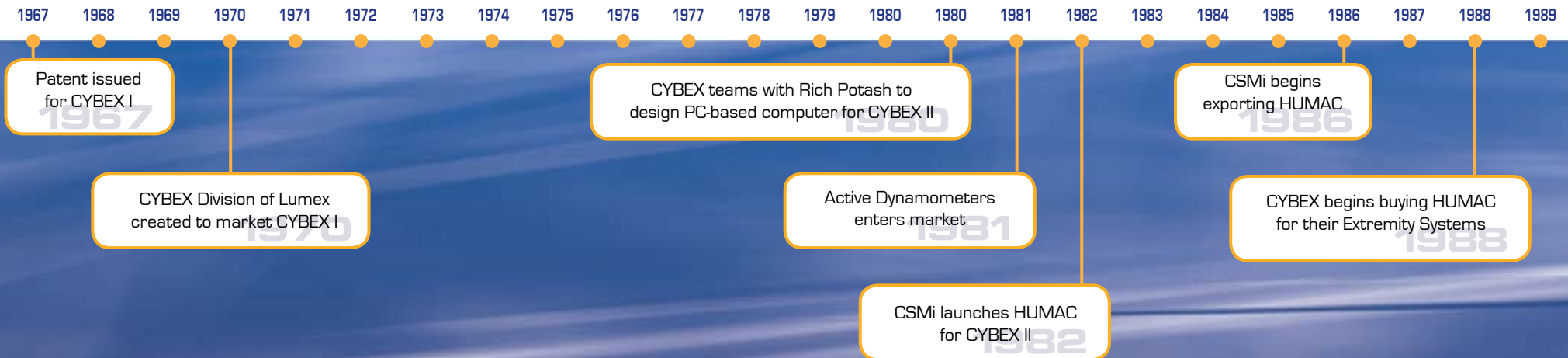



**The success of the HUMAC NORM proves we got it right when we teamed the HUMAC Computer Software with the CYBEX NORM Extremity System.**



**Rich Potash**  
President, Founder

**Rob Potash**  
Vice President

## Table of Contents



- History..... 2-3
- Solutions ..... 4-5
- Defined..... 6-7
- Patterns ..... 8-9
- Options..... 10-11

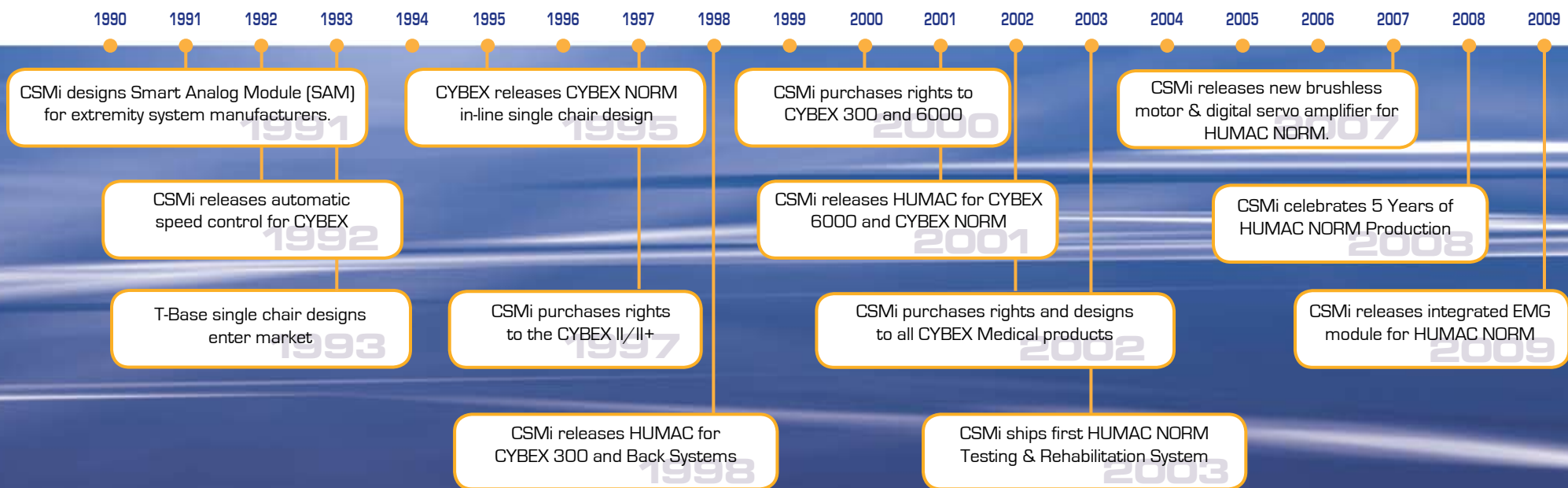

# HUMAC<sup>®</sup> NORM<sup>®</sup> Solutions

## TESTING & REHABILITATION SYSTEM

The HUMAC NORM is your solution for measuring and improving human performance in the clinic, training room, and research laboratory. In one machine the HUMAC NORM offers 22 isolated-joint movement patterns, four resistance modes (isokinetic, isotonic, isometric, and passive) and numerous reports to meet the measurement and exercise needs of today's clinicians and researchers.

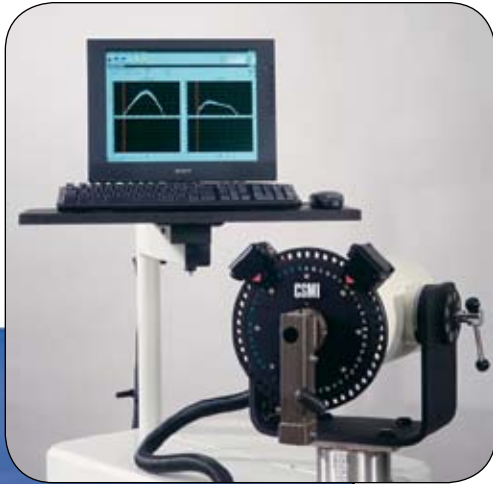

### Measurement

Only with testing can you determine baselines, set goals, and track change. The HUMAC NORM offers two primary measurement solutions.

- **Isometric Testing:** when dynamic movement is a concern, isometric testing is the answer. The HUMAC NORM will safely position the patient to each angle in the protocol. Protocol options include angles, hold-times, rest periods, repetitions, and sets.
- **Isokinetic Testing:** to determine maximum dynamic capability throughout the range-of-motion isokinetic testing is the solution. The HUMAC NORM offers concentric and eccentric resistance testing. Isokinetic-curve results make it easy determine areas of pain or weakness and determine capability.

### Exercise

Exercise is performed to improve mobility, stability, strength, and control. The HUMAC NORM offers four modes of resistance and numerous feedback options to meet these goals.

- **Passive Mode:** develop the mobility that the patient requires, from straight pattern movements to complex PNF patterns.
- **Isometric Mode:** stabilize the joint to perform angle-specific strength training.
- **Isokinetic Mode:** continue to strengthen using proven methods to enhance return-to-function including concentric and eccentric loading and deceleration training.
- **Isotonic Mode:** complete the return-to-function training using our simulated mass isotonic mode.

The HUMAC NORM Testing & Rehabilitation System is the one machine that fulfills the testing and exercise needs of today's clinicians and researchers. The HUMAC Software makes it easy to operate.

## Software

The HUMAC Software was designed with one goal in mind – enable the user to go from patient setup to report in hand as quickly as possible. Time is a limited commodity in every setting. This is why we chose to follow Microsoft recommended styling for the HUMAC Software. It is immediately recognizable to all users, so learning and operating the HUMAC NORM is a snap.

## Intuitive Steps

To perform a test or exercise simply select patient, pattern, protocol and you are ready to start the session. The next time the patient is on the HUMAC NORM the process is even faster. Select QuickTest or QuickEx to go directly from patient selection to session. The HUMAC automatically applies the test or exercise protocol used from the most recent session.

## Personalize Your Preferences

The HUMAC's Preference settings give you the flexibility to customize the software to your specific needs. Preference options include Feedback, Data Analysis, and Reporting.

## Your Software is Never Obsolete

CSMi continues to develop the HUMAC Software. And we always make sure the HUMAC Software is backwards compatible with all of our machines. From the earliest CYBEX II to the latest HUMAC NORM, your investment is never obsolete.

Visit [www.csmisolutions.com](http://www.csmisolutions.com) to see sample HUMAC screens.

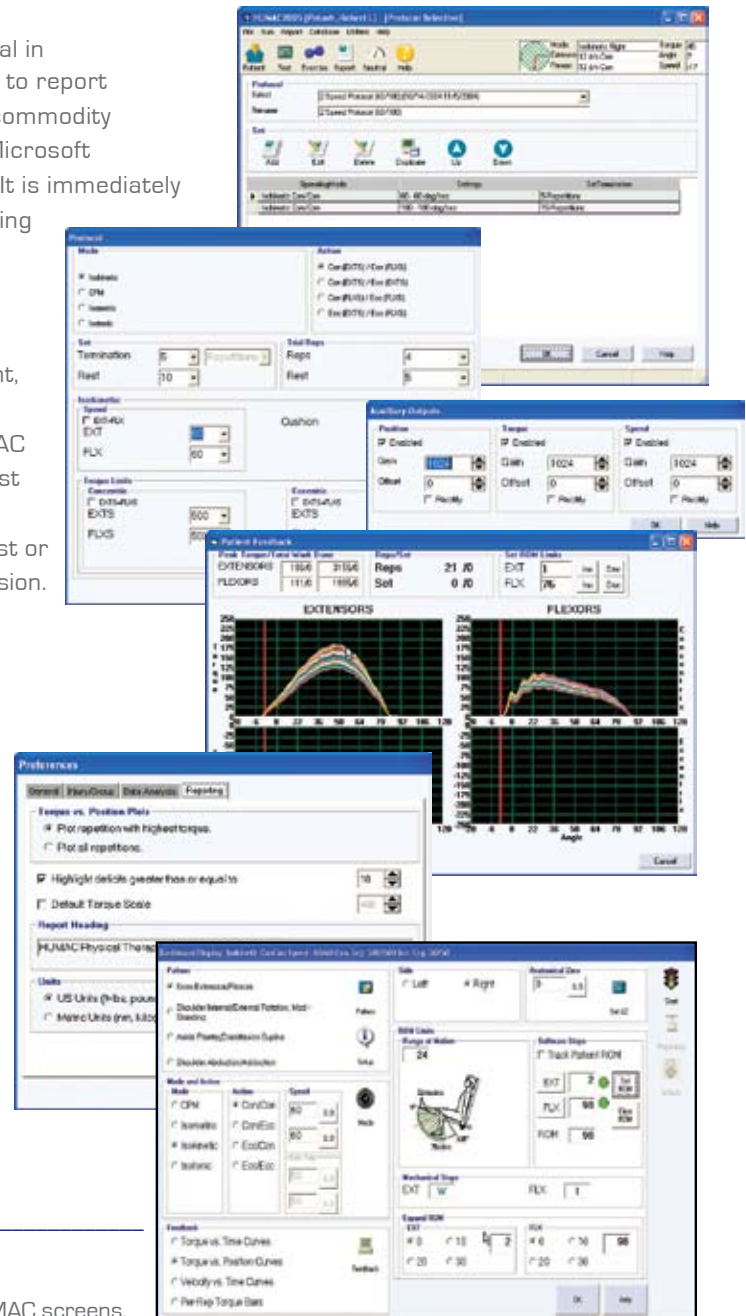

# HUMAC<sup>®</sup> NORM<sup>®</sup>

TESTING & REHABILITATION SYSTEM

## Defined

### SECURE PATIENT POSITIONING

The HUMAC NORM seat area is 1,220 square inches. The large seat, coupled with fore/aft seat back positioning and a four point seatbelt harness, accommodates and stabilizes small and big, young and old patients alike.

### MOVABLE CHAIR - FIXED DYNAMOMETER

The patented dynamometer/seat configuration minimizes floor space and adjustments, and insures quick and secure patient set-ups.

### LOCKING CLAMPS

The locking clamps secure the dynamometer and seat in place. This design offers infinite positioning options and unmatched rigidity and durability. Dual clamps allow adjustments from either side of the HUMAC NORM.

### CONTINUOUS ROTATION

The dynashaft allows continuous 360° rotation to simulate work patterns such as turning a wheel or screwdriver.

### ADJUSTABLE RANGE-OF-MOTION STOPS

With the Adjustable Range-of-Motion Stops you do not have to change adapters each time you change sides.

### MAXIMUM RESISTANCE

The HUMAC NORM dynamometer offers 500 ft-lbs. of eccentric and concentric force.



## OPTIONAL TOUCH SCREEN

Our easy-to-use HUMAC software creates a machine everyone can operate. Add a touch screen monitor to make the HUMAC NORM even faster to operate.

## CONTEXT-SENSITIVE HELP SYSTEM

Each HUMAC NORM window includes a Help button. Simply press Help and the on-line Help System opens to the very page you are on in the software.

## INTEGRATED COMPUTER SYSTEM

The integrated computer system design saves floor space, reduces cables, and guarantees the keyboard and monitor will always be within reach.

## AUXILIARY OUTPUTS (AO)

The auxiliary outputs provide easy access to torque, position, and velocity analog signals for input into other systems such as EMG. Our AO Software Control Window lets you adjust the Gain and Offset and rectify the signals to your requirements.

## HUMAC NORM Reports

The HUMAC NORM offers a variety of easy-to-read, easy-to-interpret Test, Progress, and Group Summary Reports. Reports provide the information needed to justify and track the effectiveness of treatment.

### Test Reports

The HUMAC NORM offers a variety of test report formats to meet the needs of clinicians, physicians, researchers, patients, and payers.

- Isometric
- Short Torque vs. Position or Time
- Curve Overlay
- Narrative (Isometric & Isokinetic)
- Graphic Summary
- Interactive Line & Path
- Response Time
- Repeatability
- Proprioception
- Coordination

### Progress Reports

The HUMAC NORM Progress Reports include involved and un-involved side results from initial and follow-up tests. Change in performance is presented using graphic and numeric comparisons.

### Group Summary

The HUMAC NORM Group Summary Program makes it easy to mine stored data. Using the Group Summary Program one can locate a group of patients based on pattern, protocol, and patient demographics. Once a group is located the user has the choice to export the individual calculated results for each member of the group to an Access Table, report the average and variation for the group, or compare an individual's results to a group average. Results can be sorted by right vs. left, involved vs. uninvolved, or dominant vs. non-dominant sides.

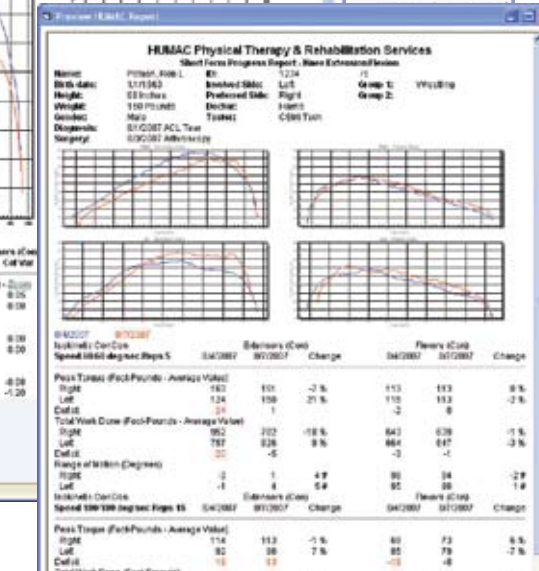
A screenshot of the 'Group Summary' program interface. It shows a 'Selection System' with a 'Pattern' dropdown set to 'Short Force (R/L)'. The 'Group Summary Statistics' section includes 'Select area' (All data, R, L, D, N, S, T, F, B, C, P, M, A, H, I, O, U, V, W, X, Y, Z, 0-9, \*, ^, #, %, &, &grave;, &copy;, &reg;, &trade;, &copy;, &reg;, &trade;) and 'Side' (Right, Left, Both, Uninvolved, Involved, Dominant, Non-dominant). The 'Access Table' section shows a list of patient records with columns for 'Name', 'Date', and 'Side'. The 'Access Table' is currently empty.

Visit [www.csmisolutions.com](http://www.csmisolutions.com) to see sample HUMAC Reports.

# HUMAC NORM<sup>®</sup> Patterns

## TESTING & REHABILITATION SYSTEM

The HUMAC NORM includes attachments to perform 22 isolated patterns covering the shoulder, elbow, wrist, hip, knee, ankle and back. Optional attachments allow trunk extension/flexion, work simulation, and closed kinetic chain patterns.

**Knee: Extension/Flexion Seated**



**Knee: Extension/Flexion Prone**



**Knee: Tibial Internal/External Rotation**



**Shoulder: Extension/Flexion**



**Shoulder: Horizontal Abduction/Adduction**



**Shoulder: Internal/External Rotation in 90° Abduction**



**Shoulder: Internal/External Rotation, Mod-Standing**



**Forearm: Pronation/Supination**



**Wrist: Extension/Flexion**



**Wrist: Radial/Ulnar Deviation**



**Elbow: Extension/Flexion**





Ankle: Plantar/Dorsiflexion Prone

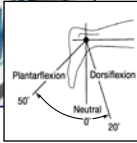

Ankle: Plantar/Dorsiflexion Supine

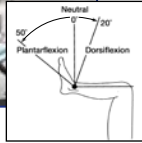

Ankle: Inversion/Eversion



Shoulder: Abduction/Adduction

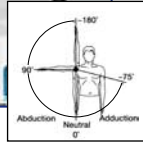

Shoulder: Internal/External Rotation, Mod-Seated

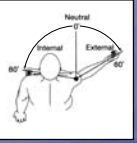

Shoulder: Internal/External Rotation in 90° Flexion

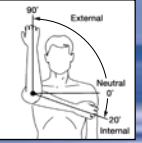

PNF D1: Flexion-Adduction/Extension-Abduction

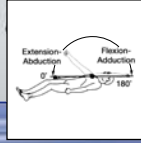

PNF D2: Flexion-Abduction/Extension-Adduction



Hip: Abduction/Adduction

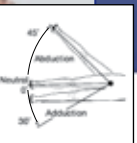

Hip: Flexion/Extension

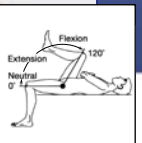

Hip: Internal/External Rotation

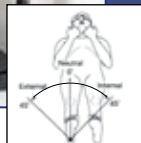

Trunk: Flexion/Extension

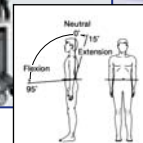

# HUMAC<sup>®</sup> NORM<sup>®</sup> Options

## TESTING & REHABILITATION SYSTEM

### Trunk Modular Component (TMC)

With the TMC the HUMAC NORM is perfectly suited for trunk testing and rehabilitation in a fully functional, standing position. The motorized footplate ensures accurate patient positioning. The low inertia input assembly and lightweight attachment enables patients to begin rehabilitation sooner.

### Johnson Anti-Shear™ Accessory

The Johnson Anti-Shear Dual Pad Accessory with adjustable fulcrum allows the clinician to select the correct amount of counterforce necessary to control anterior shear during knee extension. This prevents excessive stress on repairs, healing, or chronically lax ligaments.

### Work Simulation Package

The Work Simulation Package allows clinicians to simulate an unlimited number of real-life and occupational patterns. The attachments include an assortment of handles and knobs, a steering device, a gripping device, and a push/pull device. Because the HUMAC NORM's dynamometer shaft allows full 360° rotation you enjoy a greater range of exercise options.

### Closed Kinetic Chain (CKC) Accessory

The CKC expands the HUMAC NORM from a rotary device to a linear device. Use the rugged CKC to test and exercise patients in linear, closed chain patterns. The CKC includes attachments to perform a single and bilateral leg press, and bilateral chest press.

### Color Coordinated

The HUMAC NORM color scheme includes black plastic shroud, storm gray frame, yellow actuating components, and black upholstery. If your upholstery needs are different we invite you to select the color you need. Custom upholstery will slightly increase price and delivery time.

### Integrated EMG Module

The HUMAC NORM Integrated EMG Module allows the user to control their EMG hardware from the HUMAC NORM Program. This configuration eliminates the need for a 2nd computer, has the HUMAC directly control the EMG System, creates a centralized database containing EMG and Extremity System data, and lets the user manage their data via the HUMAC NORM Group Summary.



Trunk Modular Component (TMC)



Johnson Anti-Shear™ Accessory



Work Simulation Package



Closed Kinetic Chain (CKC) Accessory

## RESEARCH TOOLKIT

The Research Toolkit gives the researcher direct access to the widest range of dynamometer control settings. Sampling rate and feedback scales are adjustable on the fly. And when ready simply press Save to store torque, position, and velocity results directly to Excel. Also includes Group Test Module.

## GROUP TEST MODULE

The optional HUMAC Group Test Module saves time during continuous same day testing of subjects when the same pattern and protocol are used. Set Pattern and Protocol, select Subject, run test and select next Subject until done.



Research Toolkit

## Resistance Modes

### Mode

Isokinetic Concentric  
Isokinetic Eccentric  
CPM  
Isometric  
Isotonic

### Speeds

$\frac{1}{16}$ - 500<sup>o</sup> per sec  
 $\frac{1}{16}$ - 500<sup>o</sup> per sec  
 $\frac{1}{16}$ - 500<sup>o</sup> per sec

### Torque

500 ft-lbs/678 Nm  
500 ft-lbs/678 Nm  
500 ft-lbs/678 Nm  
500 ft-lbs/678 Nm  
500 ft-lbs/678 Nm

## Suggested Floor Plan

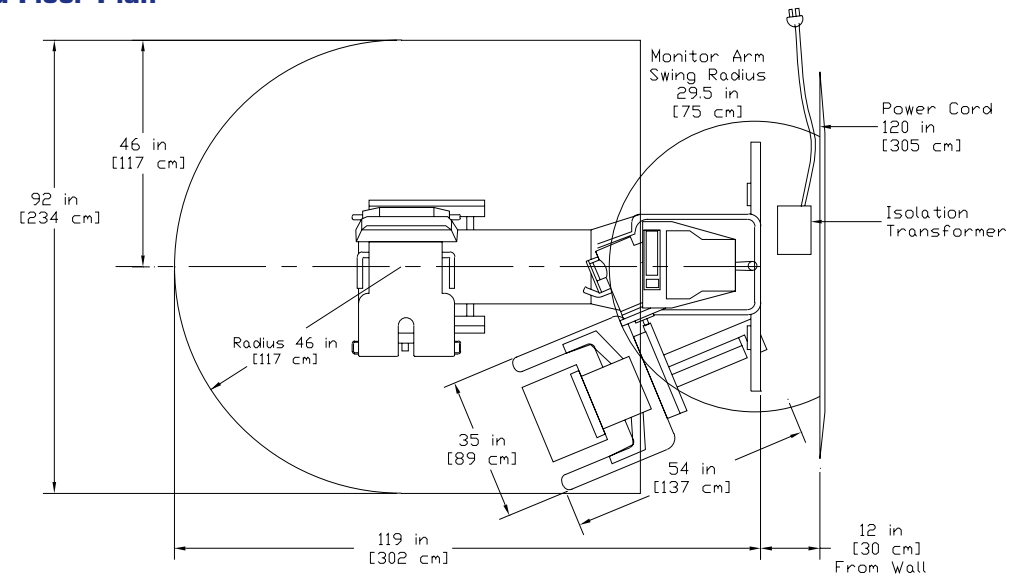

## Electrical Specifications

Independent 20 Amp single phase line. Can be configured for input voltages between 184 and 259 VAC. Shipped configured for 208 VAC. Recommended outlet receptacle NEMA 6-20R (Hospital Grade)

## Power Requirements

Input Voltage: 220 VAC (other voltages available)  
Input Frequency: 60Hz (international frequency 50Hz available)  
Independent 20 amp dedicated circuit required

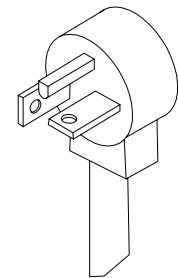
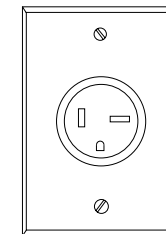

Visit [www.csmisolutions.com](http://www.csmisolutions.com) to learn more about HUMAC options.

# CSMi Medical Solutions Products

- HUMAC NORM Testing & Rehabilitation System
- HUMAC Update for CYBEX NORM, 6000, 300, and II/II+
- HUMAC SmartLift Closed Loop Functional Trainer
- PVI Home Exercise Software
- SportsWare Injury Tracking Software

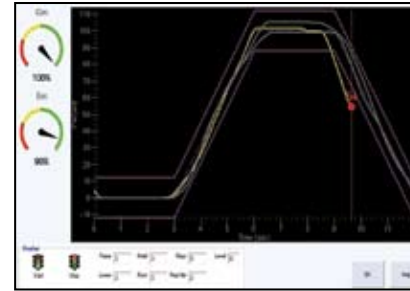

Roadway

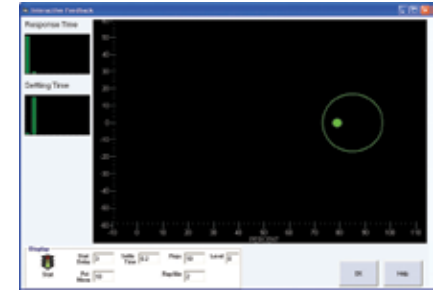

Response

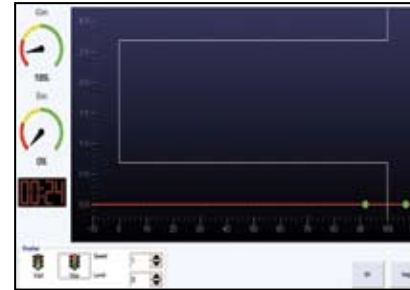

Proprioception

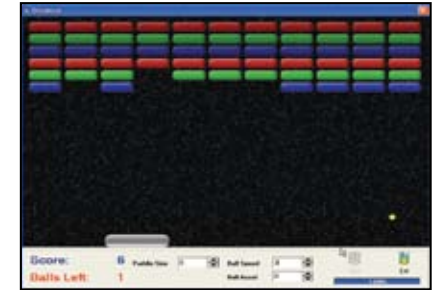

Breakout



Isometric Report

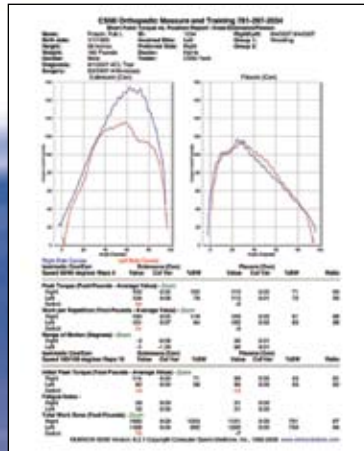

Short Report

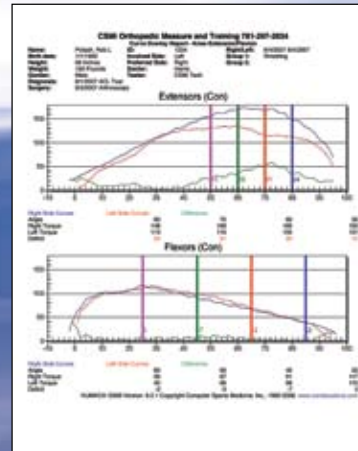

Curve Overlay Report

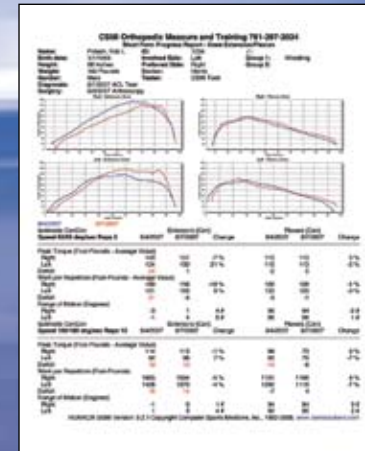

Progress Report



Patient vs. Group Report



(phone) 781.297.2034  
 (fax) 781.297.2039  
 (web) www.csmisolutions.com  
 (e-mail) info@csmisolutions.com



CSMi is a sole-source provider of the HUMAC Computer System and exclusive owner of the CYBEX Medical Products. CSMi, HUMAC, NORM, & Kinetron are registered trademarks of CSMi. Copyright © 2009, CSMi. All names, products, and services mentioned are trademarks or registered trademarks of their respective companies. Patents: 4,725,056; 5,722,937